

**cattelan  
italia**

---

# **WALL STREET**

**ISTRUZIONI DI MONTAGGIO ASSEMBLING INSTRUCTIONS MONTAGEANLEITUNG  
INSTRUCTIONS DE MONTAGE INSTRUCCIONES DE MONTAJE**

Cattelan Italia spa si riserva di apportare, senza preavviso, modifiche nei materiali, nei rivestimenti, nelle finiture e nei disegni dei prodotti presentati in questo catalogo. Le textures ed i colori dei materiali e delle finiture hanno valore indicativo in quanto soggetti alle tolleranze dei processi di stampa.

Cattelan Italia spa reserves the right to change, without previous notice, materials, covers, finishes and drawings of the products presented in this catalogue. The textures and colours of materials and finishes are indicative as they are depending on the tolerances of the printing process.

Cattelan Italia spa behaltet sich vor, ohne Vorankündigung, Veränderungen an den Materialien, Bezügen, Finish und Zeichnungen der in diesem Katalog vorgestellten Produkte vorzunehmen. Die Texturen und Farben der Materialien und Finish haben einen hinweisenden Wert, da sie von den Toleranzen im Druckprozess abhängig sind.

Cattelan Italia spa se réserve le droit d'apporter, sans préavis, des modifications au niveau des matériaux, des revêtements, des finitions et du design des produits présentés dans ce catalogue. Les textures et les couleurs des matériaux et des finitions sont une valeur indicative parce-que ils changent selon la tolérance aux procédés d'imprimerie.

Cattelan Italia spa se reserva el derecho de aportar modificaciones de dibujo, materiales, acabados y tapicerías, sin que esté obligada a dar aviso anticipado. Las textures y los colores de los materiales y de los acabados tienen solo un valor indicativo porque están sujetos a la tolerancia en los procesos de imprenta.

**IMPORTANTE: Riporre per eventuali consultazioni future!!!!**

**IMPORTANT: File for future consultation!!!!**

**WICHTIG: Bitte aufbewahren für eventuelle spätere Nachfragen!!!!**

**IMPORTANT: A conserver pour les futurs besoins de référence!!!!**

**¡IMPORTANTE: Guardar para consultas posteriores!**

# WALL STREET

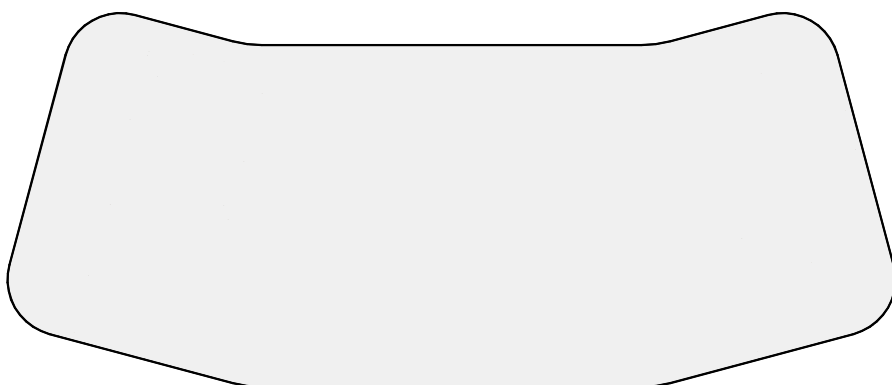
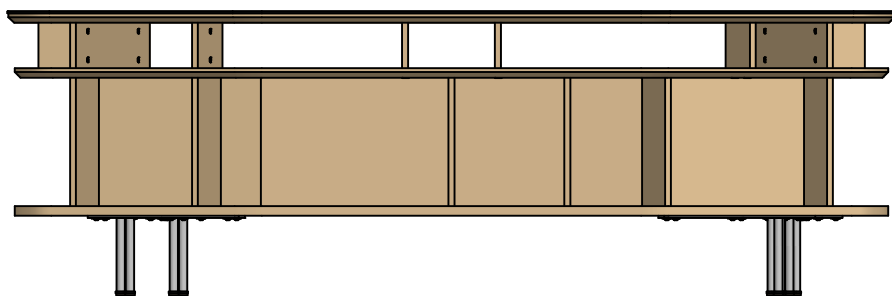

n° 12 TPSCE M8x20 N.

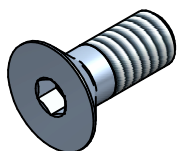

n° 24 TBCE M8x20 N.

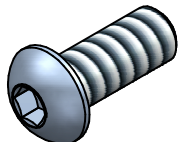

n° 24 rondella ø8x24 N.

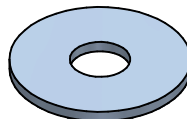

n° 44 spine legno ø6x30.

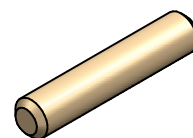

n° 10 tirante ø6x26 ZB.

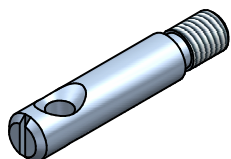

n° 10 barilotto ø10 ZB.



n° 10 grano PC M6x6 ZB.

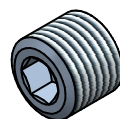

n° 06 TCCE M6x140 N.

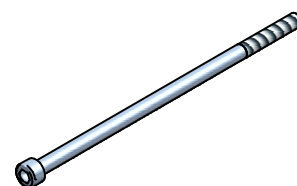

n° 06 ranella N.



n° 10 PVC adesivo ø13.



n° 06 PVC adesivo ø17.



n° 01 da 03.  
n° 01 da 05.

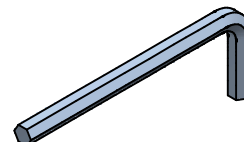

# WALL STREET

1

**IMPORTANTE!!!!!! - VERY IMPORTANT!!!!!!  
WICHTIG!!!!!! - TRÈS IMPORTANT!!!!!!  
¡MUY IMPORTANTE!**

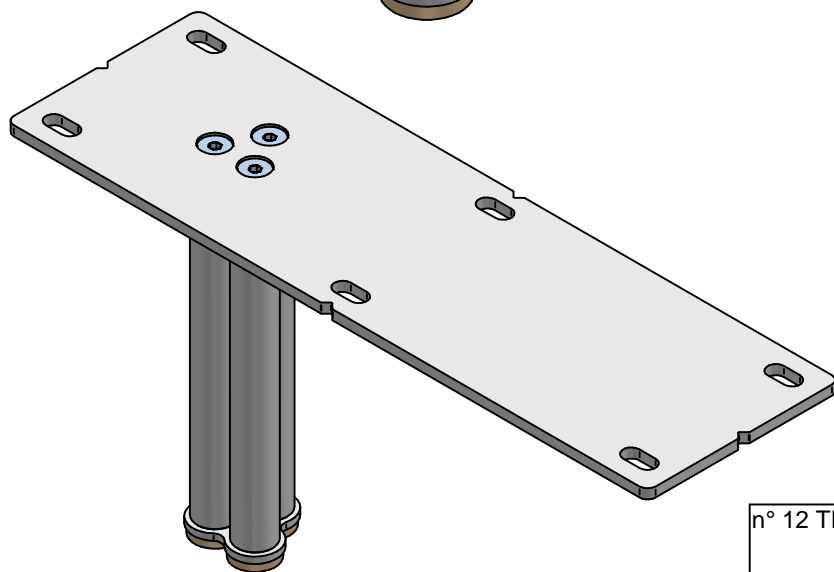
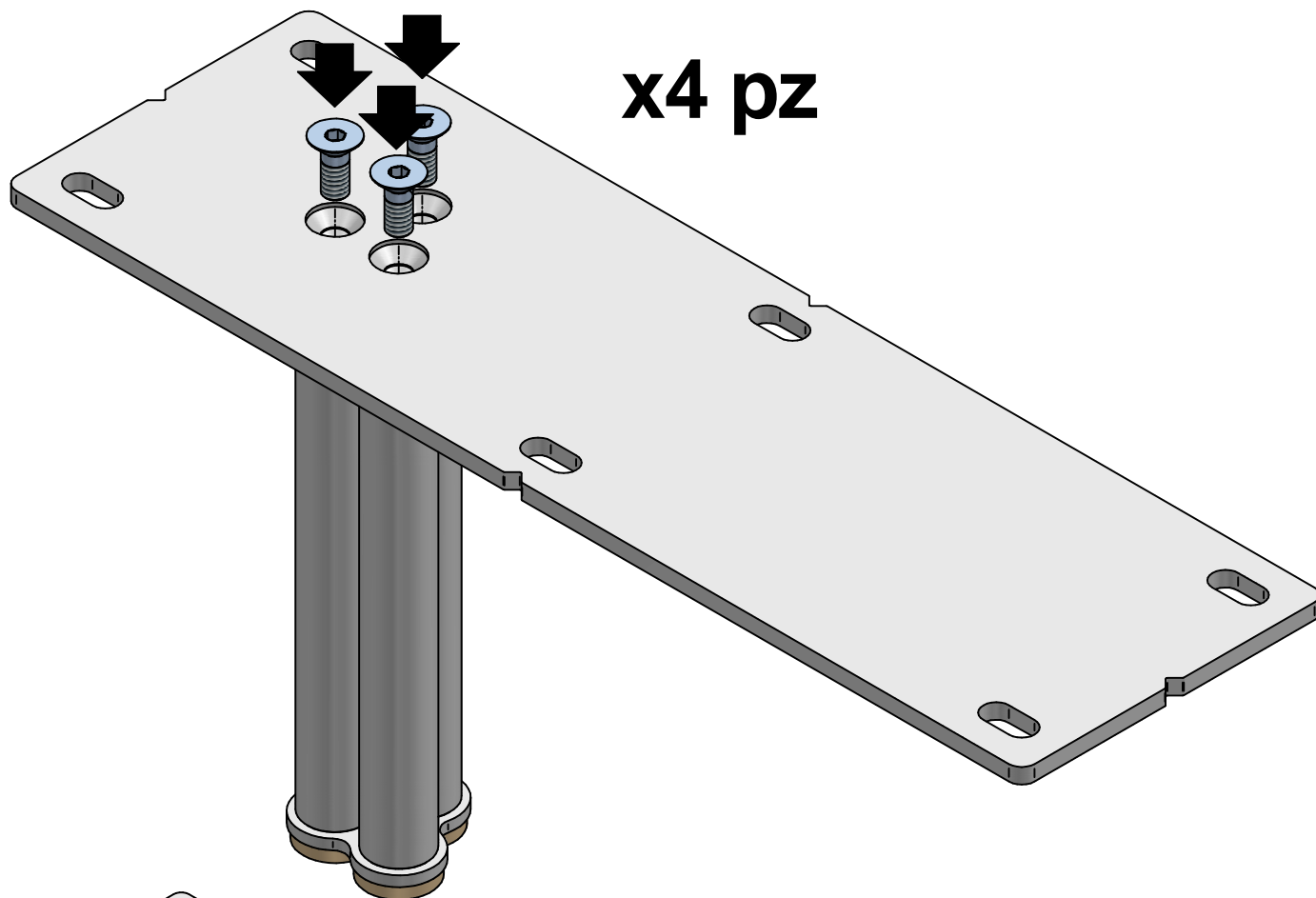

n° 12 TPSCE M8x20 N.

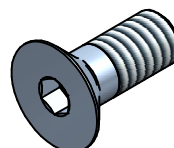

n° 01 da 05.

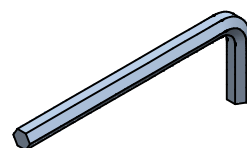

# WALL STREET

2



**IMPORTANT!!!! - VERY IMPORTANT!!!!**  
**WICHTIG!!!! - TRÈS IMPORTANT!!!!**  
**¡MUY IMPORTANTE!**

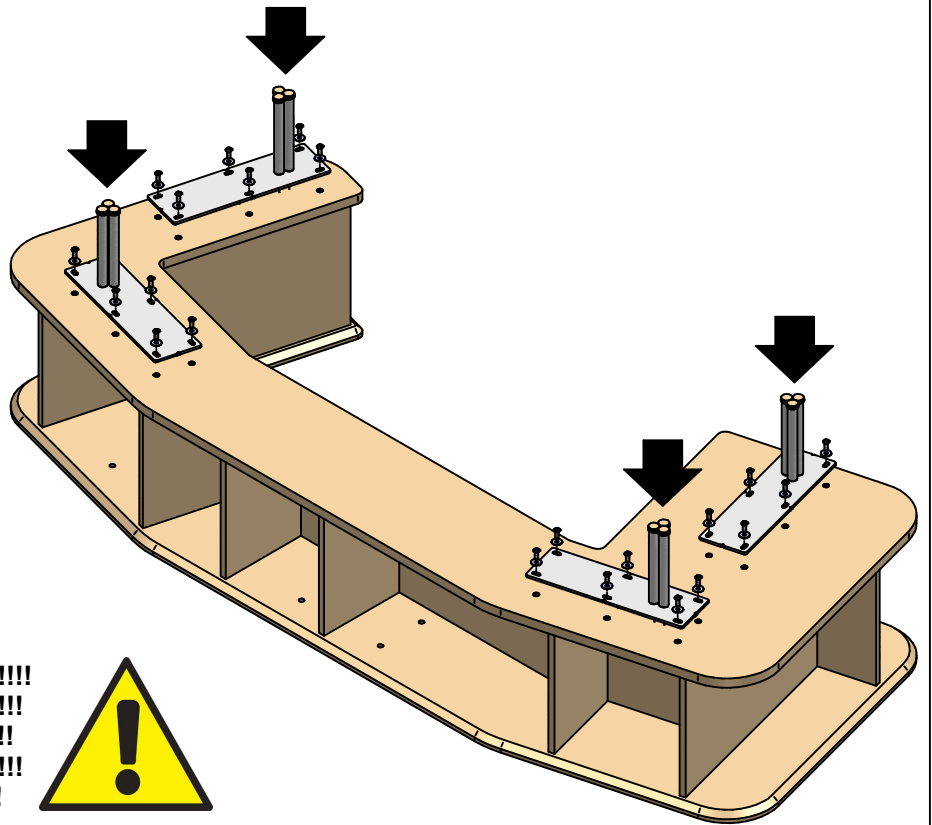

**ATTENZIONE!!!!**  
**ATTENTION!!!!**  
**ACHTUNG!!!!**  
**¡ATENCIÓN!**



**IMPORTANT!!!!**  
**VERY IMPORTANT!!!!**  
**WICHTIG!!!!**  
**TRÈS IMPORTANT!!!!**  
**¡MUY IMPORTANTE!**



**ATTENZIONE!!!!**  
**ATTENTION!!!!**  
**ACHTUNG!!!!**  
**¡ATENCIÓN!**

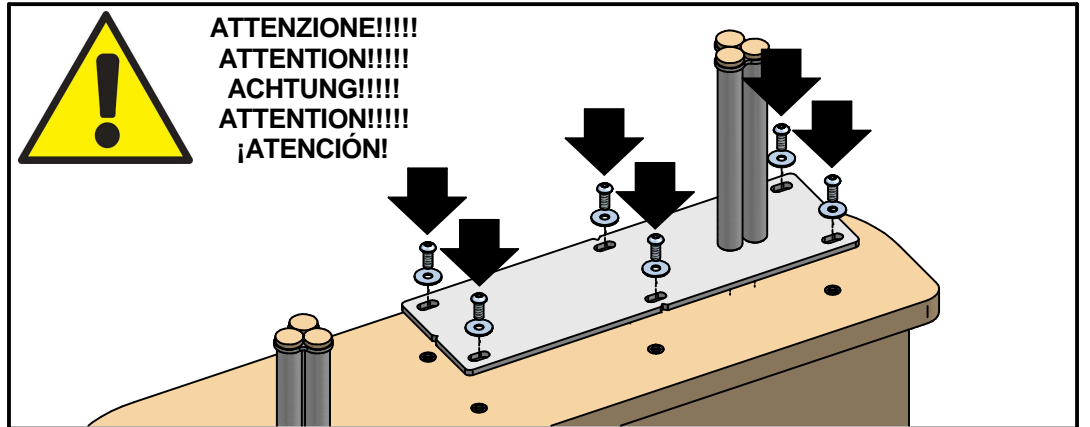

n° 24 TBCE M8x20 N.

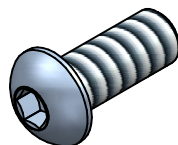

n° 24 rondella ø8x24 N.

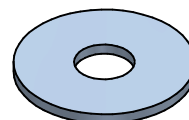

n° 01 da 05.

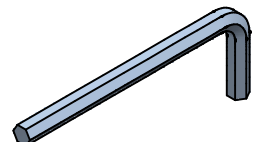

# WALL STREET

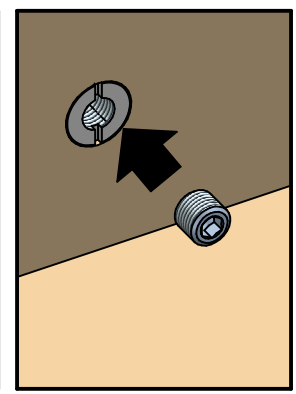
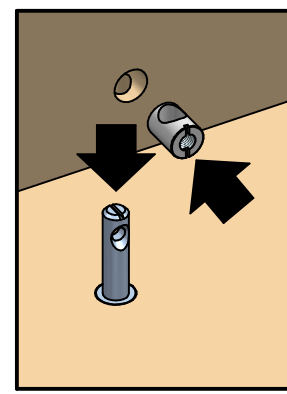
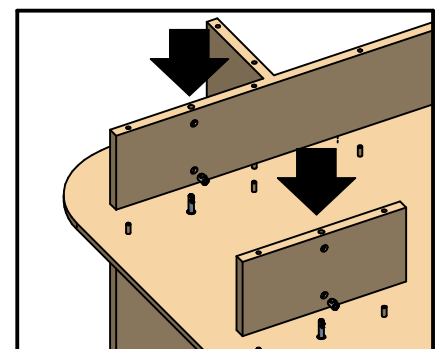
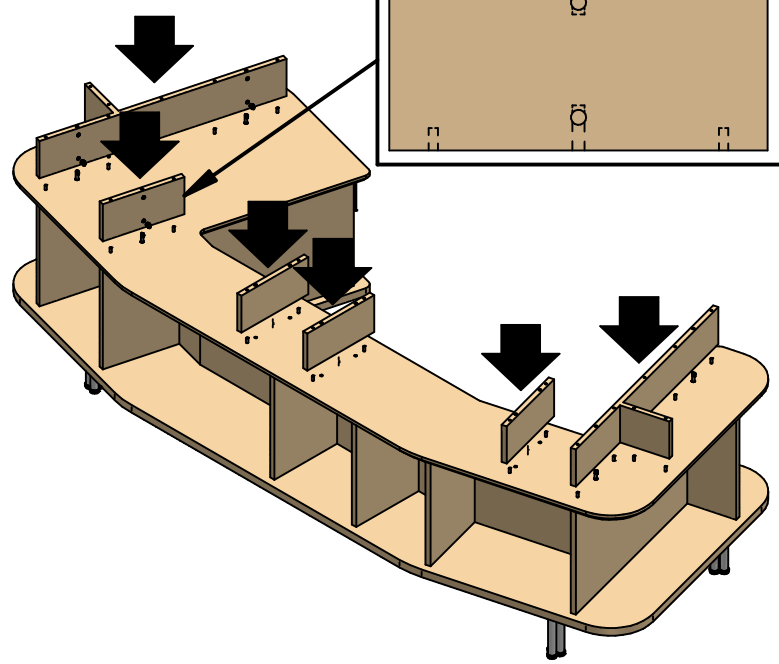
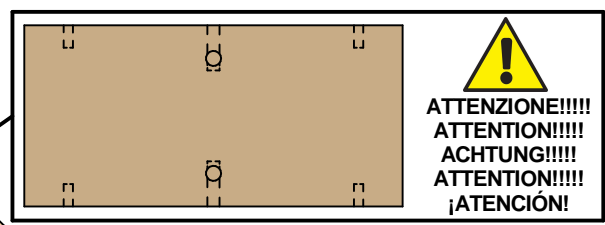
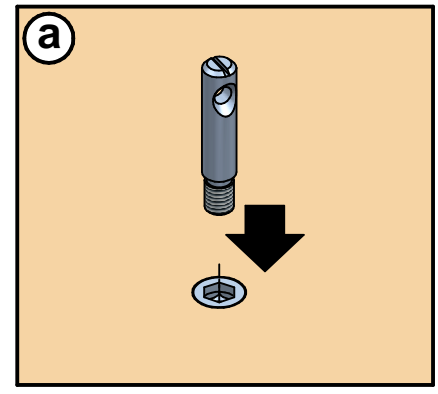
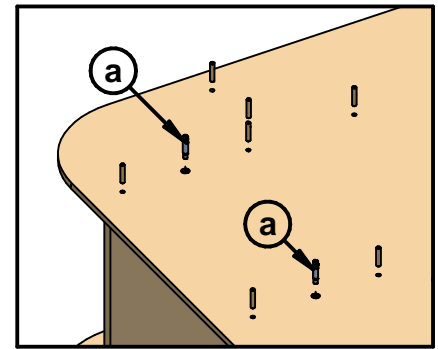
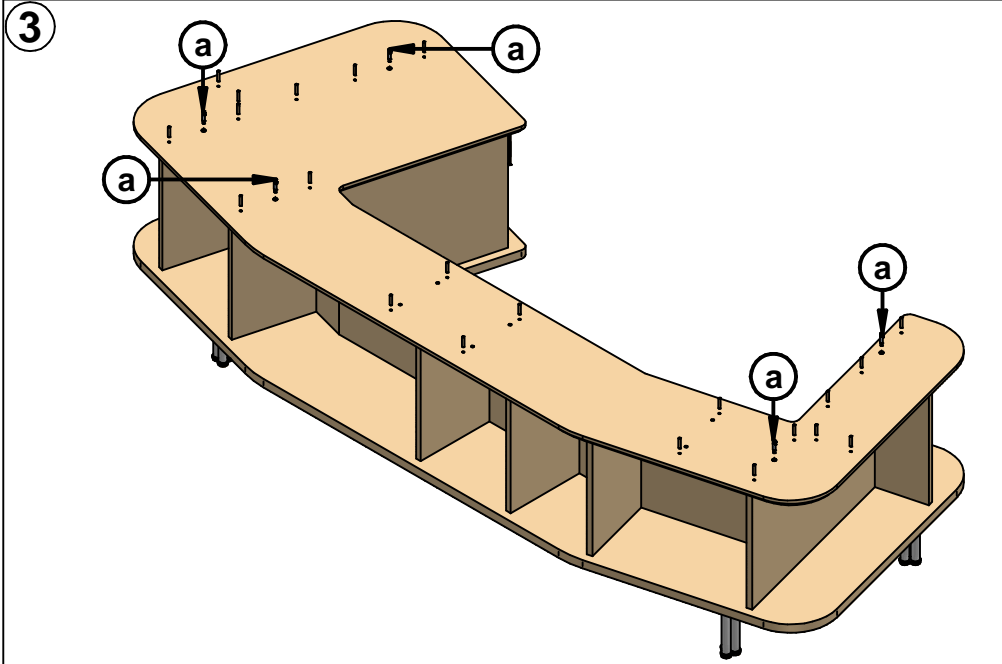

n° 05 grano PC M6x6 ZB.



n° 22 spine legno ø6x30.

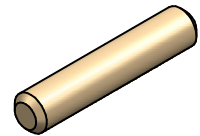

n° 05 tirante ø6x26 ZB.

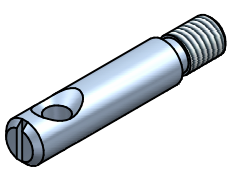

n° 05 barilotto ø10 ZB.



n° 01 da 03.

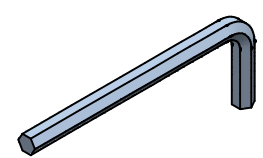

# WALL STREET

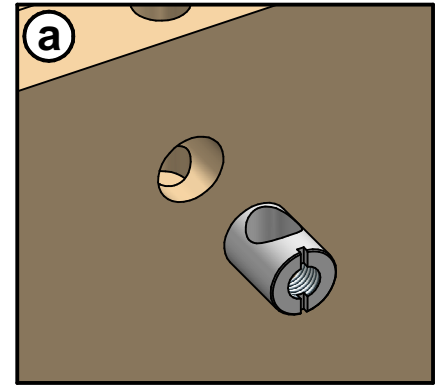
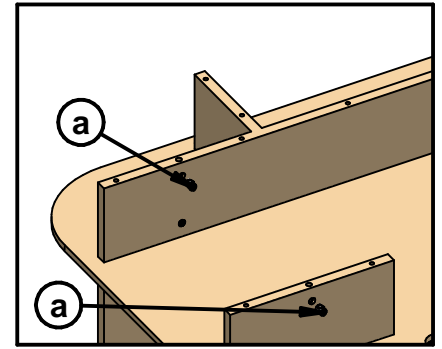
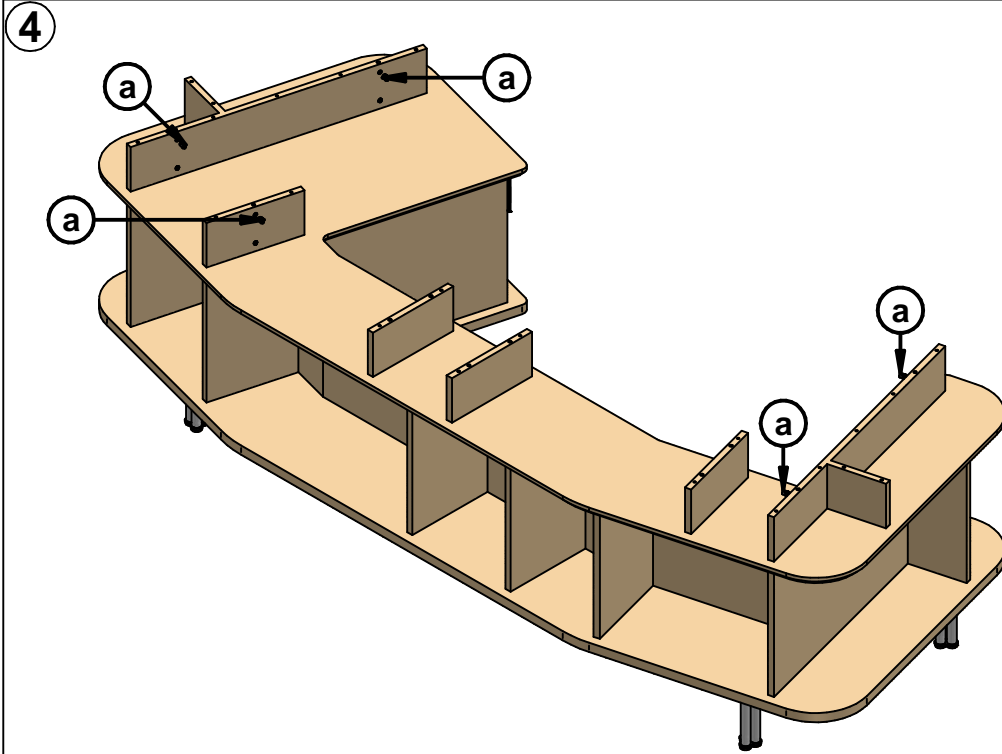

	<b>IMPORTANTE!!!!</b> <b>VERY IMPORTANT!!!!</b> <b>WICHTIG!!!!</b> <b>TRES IMPORTANT!!!!</b> <b>¡MUY IMPORTANTE!</b>	
<b>IMPORTANTE!!!! - VERY IMPORTANT!!!!</b> <b>WICHTIG!!!! - TRES IMPORTANT!!!!</b> <b>¡MUY IMPORTANTE!</b>		

**ATTENZIONE!!!!**  
**ATTENTION!!!!**  
**ACHTUNG!!!!**  
**ATTENTION!!!!**  
**¡ATENCIÓN!**

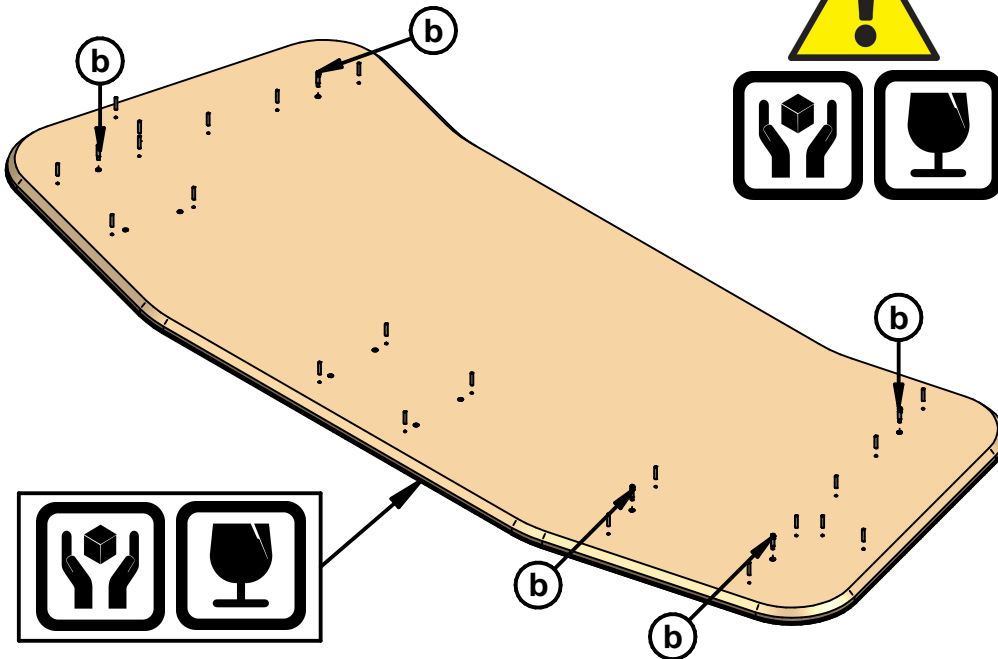
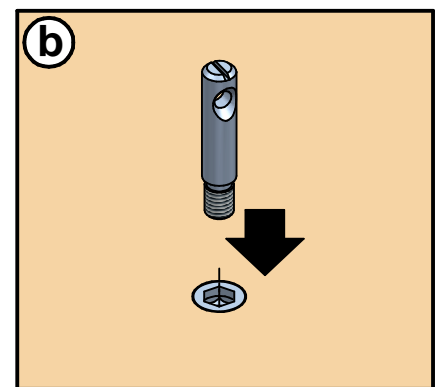
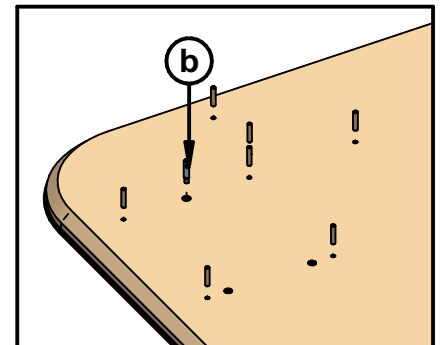
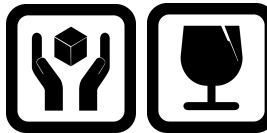

n° 05 tirante ø6x26 ZB.

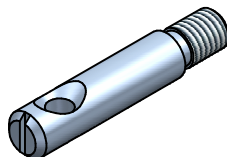

n° 05 barilotto ø10 ZB.



n° 22 spine legno ø6x30.

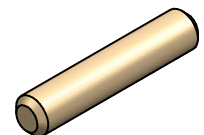

# WALL STREET

5

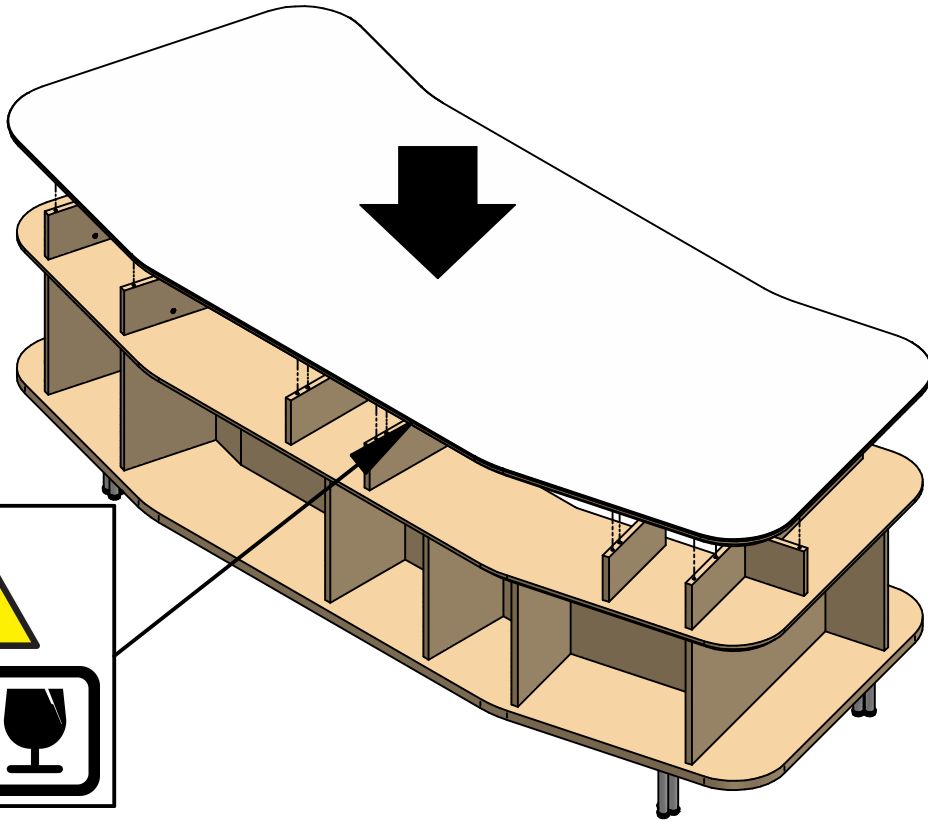

**ATTENZIONE!!!!**  
**ATTENTION!!!!**  
**ACHTUNG!!!!**  
**ATTENTION!!!!**  
**¡ATENCIÓN!**

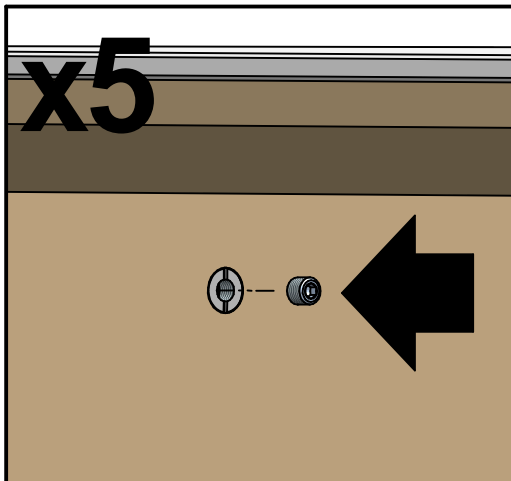
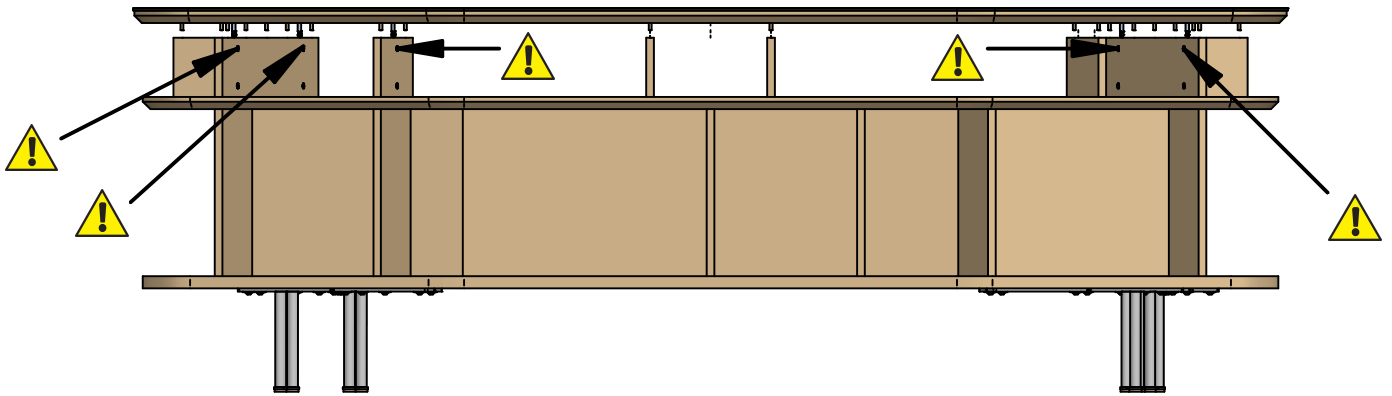
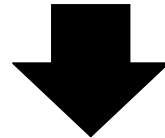
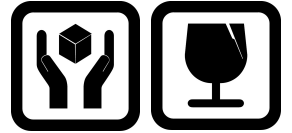

n° 05 grano PC M6x6 ZB.

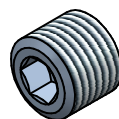

n° 01 da 03.

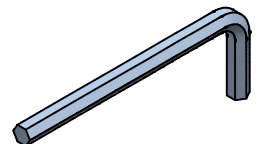



# WALL STREET

6

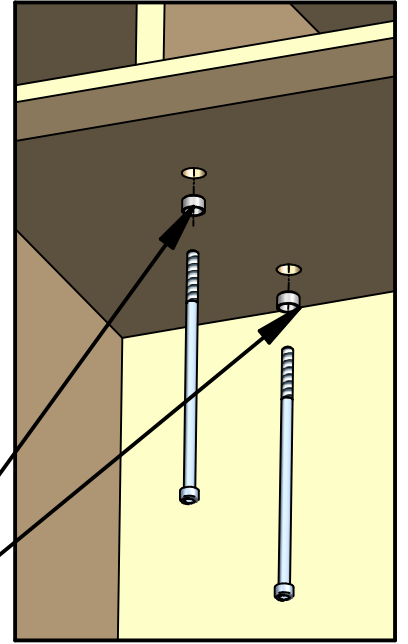
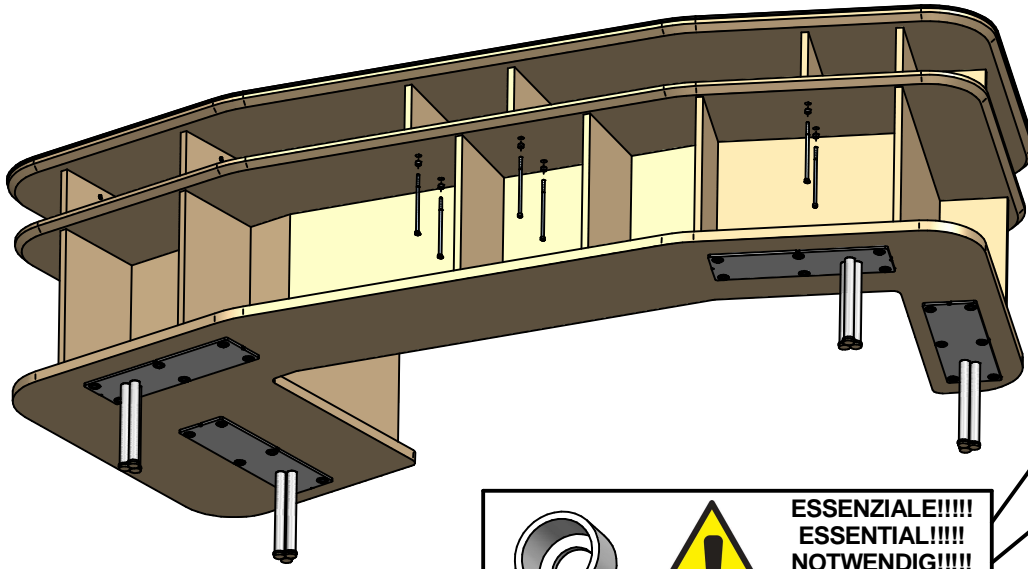

**ESSENZIALE!!!!**  
**ESSENTIAL!!!!**  
**NOTWENDIG!!!!**  
**ESSENTIEL!!!!**  
**¡ESENCIAL!**

7

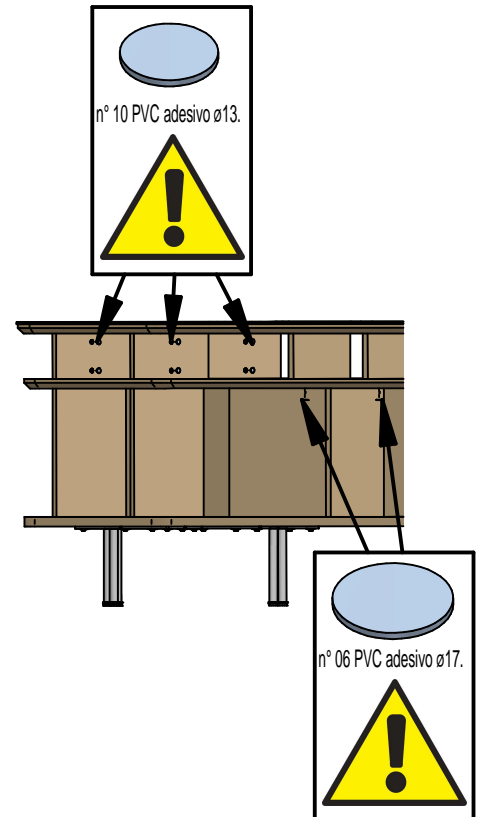
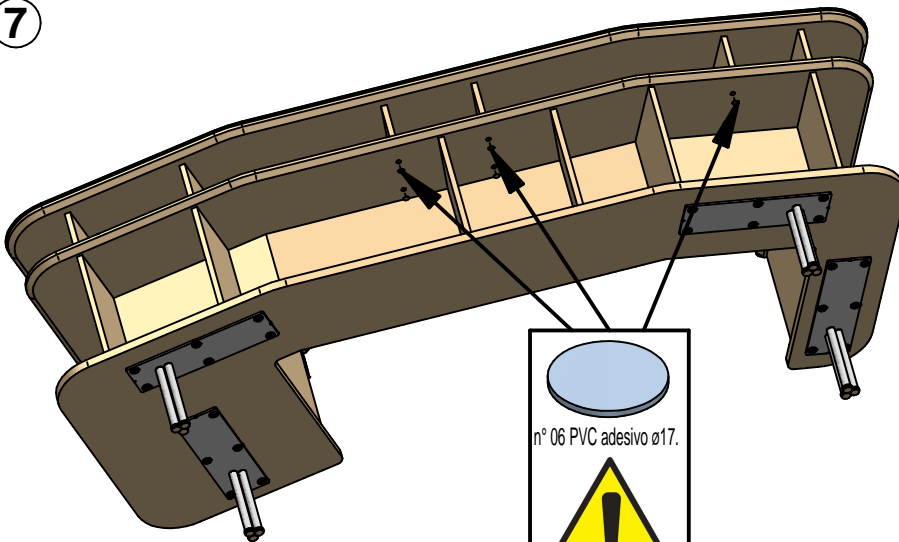

n° 06 ranella N.



n° 06 TCCE M6x140 N.

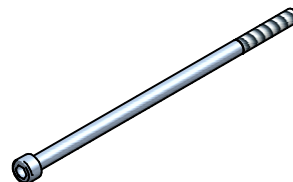

n° 01 da 05.

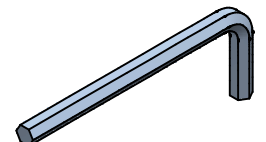



## USO

Il prodotto é destinato per l'utilizzo all'interno delle abitazioni con l'uso per il quale é stato realizzato.



### REALIZZAZIONE



**Piccole irregolarità sulla base sono dovute alla lavorazione manuale del prodotto.**

### MANUTENZIONE

Non vanno assolutamente utilizzati strumenti metallici appuntiti o panni abrasivi per eliminare eventuali residui di sporco presenti sulla superficie del prodotto, in quanto possono danneggiare la superficie stessa. Non vanno assolutamente utilizzati detersivi che contengano cloro o a base di acido cloridrico, acido muriatico o prodotti anticalcare in quanto andrebbero ad alterare la brillantezza del prodotto.

### ATTENZIONE

Non spostare assolutamente mai il prodotto trascinandolo o sollevandolo prendendolo per il piano ma smontarlo e riposizionarlo dove voluto, assicurandosi di proteggere le parti che si potrebbero danneggiare.



### SMALTIMENTO

Una volta dismesso, il prodotto od i suoi componenti non vanno dispersi nell'ambiente ma conferiti ai sistemi pubblici di smaltimento.



**Riporre per eventuali consultazioni future.**



## USE

The product is intended to be used in the inside and for the purposes it was created for.



### ACCOMPLISHMENT



**Small irregularities on the base are due to manual processing.**

### MAINTENANCE

It is recommended not to use metal sharp tools or abrasive clothes to eliminate dirt from the surface, because they could damage the same. Do not absolutely use detergents containing chlorine, muriatic acid, hydrochloric acid or descale detergents which can damage the surface brilliance.

### WARNING

Do not absolutely move the product dragging it or lifting it by gripping the top, but disassemble it and then place it in the new site, protecting the parts that could be damaged.



### DISPOSAL

Once discarded, neither the product nor its components should be dispersed in the environment, but rather consigned to public disposal systems.



**File for future consultation.**



## NUTZUNG

Das Produkt ist nur für den Innenbereich gedacht. Der Tisch wurde hergestellt, nur als Esstisch genutzt zu werden.



### AUSFÜHRUNG



**Kleine Unregelmäßigkeiten auf der Basis sind nicht zu vermeiden, da das Teil per Hand hergestellt wird.**

### WARTUNG

Niemals scharfe Werkzeuge aus Metall, spitzen Instrumente oder Schleifmittel für die Reinigung der Oberfläche verwenden. Diese Produkte können die Oberfläche beschädigen. Niemals Chemikalien mit chlorhaltigen Salzsäure, Salzsäure oder Kalk-Produkte für die Reinigung verwenden. Diese Produkte können der Glanz beschädigen.

### ACHTUNG

Der Tisch absolut nie ziehen oder heben. Falls der Tisch soll bewegt werden, muss zerlegt werden und sorgfältig in der neue Stelle Positioniert. Die empfindliche teile sollen geschützt werden.



### ENTSORGUNG

Nach der Aussonderung ist das Produkt und seine Bestandteile nicht selbständig im Freien zu entsorgen, sondern der städtischen Müllabfuhr zu übergeben.



**Bitte aufbewahren für eventuelle spätere Nachfragen.**

## **F** UTILISATION



Le produit est destiné pour une utilisation à l'intérieur des habitations.

### **CONSTRUCTION**

**Les petites irrégularités sur la base sont dues à une fabrication manuelle.**

### **MANUTENTION**

Il ne faut pas absolument utiliser des outils pointus ou des chiffons abrasifs pour éliminer des possibles restes sur la surface du produit, parce qu'ils peuvent endommager la surface même. Ne pas utiliser des détergents contenant du chlore, acide chlorhydrique, acide muriatique ou produits anticalcaire qui peuvent altérer le brillant du produit.

### **ATTENTION**

Ne pas absolument déplacer le produit en le trainant ou en le soulevant par le top, mais démontez-le et positionnez-le autre part, en s'assurant de protéger les parties qui pourraient s'endommager.



### **ECOULEMENT**

Une fois disloqué, le produit ou ses composants ne doivent pas être dispersés dans la nature mais confiés aux décharges publiques.



**A conserver pour les futurs besoins de reference.**

## **E** USO



El producto está destinado para su uso dentro del hogar, a los fines por los cuales fue creado.



### **CONSTRUCCIÓN**

**Pequeñas irregularidades en la base están causadas por la producción manual.**

### **MANTENIMIENTO**

No utilizar en cualquier forma instrumentos de metal afilados o telas abrasivas para eliminar cualquier resto de suciedad en la superficie del producto, ya que pueden dañar la superficie misma. No utilizar en cualquier forma limpiadores a base de cloro o que contienen ácido clorhídrico, ácido muriático o productos anticalcáreos ya que pueden alterar el brillo del producto.

### **ATENCIÓN**

No muevan absolutamente nunca el producto arrastrándolo o mediante el levantamiento del plano, sino desmontarlo y llevarlo a donde querían, asegurándose de proteger las partes que pueden dañarse.



### **ELIMINACIÓN DE DESECHOS**

Una vez desechado, el producto o sus componentes no se tienen que abandonar en el entorno sino entregar al sistema público de recogida de basuras.



**Guardar para consultas posteriores.**

**IMPORTANTE: Riporre per eventuali consultazioni future!!!!**

**IMPORTANT: File for future consultation!!!!**

**WICHTIG: Bitte aufbewahren für eventuelle spätere Nachfragen!!!!**

**IMPORTANT: A conserver pour les futurs besoins de reference!!!!**

**¡IMPORTANTE: Guardar para consultas posteriores!**

**cattelan  
italia**

---

CATTELANITALIA.COM



CATTELAN ITALIA SPA – via pilastri 19 – 36010 Carré / Vicenza – Italy  
phone +39 0445 318711 - fax +39 0445 314289 - email: [info@cattelanitalia.com](mailto:info@cattelanitalia.com)